

Legal Requirements

The main reason for installing an emergency lighting system is to enable the building to meet fire safety legislation in a way that is visually acceptable and meets the user's needs for ease of operation and maintenance. Consequently it is important to establish all the relevant legal requirements for emergency lighting and fire alarm systems before commencing the design. These should ideally be agreed between the "responsible person" and the system designer.

The main legislative requirements are:

The Fire Safety Order 2005

(The Fire (Scotland) Act 2005 and Fire and Rescue Services (Northern Ireland) Order 2006 No.1254), reforms the way the law relating to fire safety in non-domestic premises and specifically replaces the Fire Precautions (workplace) regulation 1997 and the Fire Precautions Act 1971. It imposes a general duty to take such fire precautions as may be reasonably required to ensure that premises are safe for the occupants and those in the immediate vicinity.

By virtue of the order the Responsible Person (for Scotland the Duty Holder) is required to carry out a fire risk assessment of their premises. If not trained themselves, the Responsible Person must appoint, or contract, a 'Competent Person' to carry out a risk assessment. This must be a suitable and sufficient assessment of the risk to which relevant persons are exposed for the purpose of identifying the general fire precautions they need to take to comply with the requirements of the order.

This legislation requires that all premises must be safeguarded from fire by appropriate fire safety precautions.

- This must be demonstrated by the responsible person for the premises (normally the employer) conducting a fire safety risk assessment. If the site has 5 or more employees then the risk assessment must be kept as a formal record for inspection by the Fire Authority.
- The Assessment replaces fire certificates which are now no longer valid.

Main points in the guide are:

- That the law now covers all premises that have employees or are visited by members of the public. (Previously, fire certificates did not cover small premises).
- Emergency lighting should be upgraded to meet the current standards. (Previously premises did not have to be upgraded when standards improved, now those engineered to previous issues need to be brought up to date).

The building regulations detail the design and construction characteristics of a building. Approved Document B details the fire safety requirements for new buildings and the major refurbishment of existing premises. Table 9 of this document shows the locations that must be provided with emergency lighting. This list should be used as a starting point and BS5266-1:2011 should be referred to as the main source of information. This provides information for areas requiring emergency lighting but also best practice for the lighting of a selection of high risk tasks. It also clarifies that emergency lighting is needed for all parts of schools that either do not have natural light or are used outside normal school hours. The regulations require that systems comply with BS 5266-1:2011 the code of practice for emergency lighting.

In order for greater clarity, it is now split into two separate volumes: Volume 1 for Dwellings and Volume 2 for Buildings Other Than Dwelling Houses.

Emergency Design Process Chart

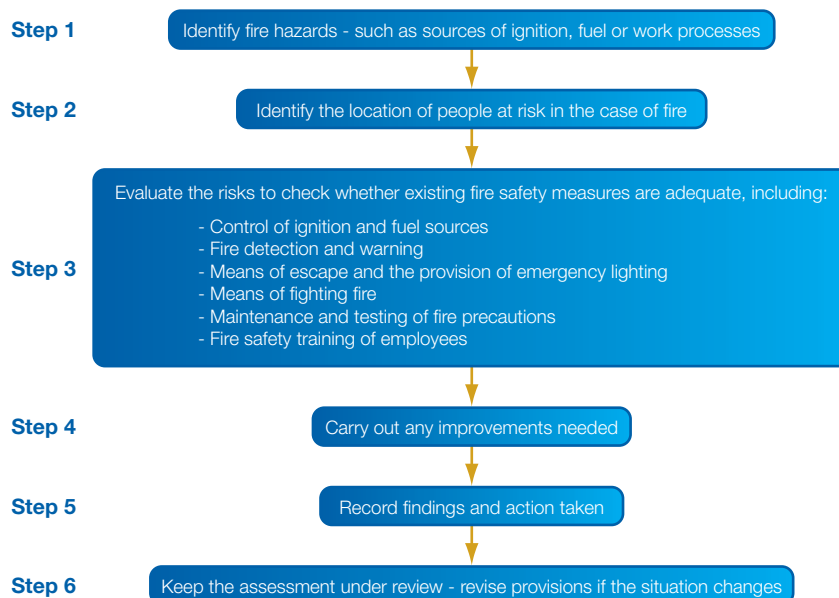

The Fire Safety Order 2005 (cont'd)

The Government has produced 11 guides for individual applications to help employers to conduct their assessments and gives guidance on the safety equipment required.

The guides make it clear that occupants have to be protected from risks in the event of the normal supply failing. To assist users they advise that:

- Emergency lighting is likely to be required where any escape routes are internal and without windows or if the premises are used during darkness (including early darkness in winter).
- The assessment should cover the location of employees and any visitors (including information on those persons with disabilities) to the site to assist in determining the areas requiring emergency lighting.
- The guidance gives detailed requirements for the suitability of escape routes and calls for the installation of emergency lighting to be in accordance with BS 5266-1.
- The risk assessment should identify any areas that require additional emergency lighting provision. BS5266-1:2011 lists examples of these areas detailing the required levels, duration, and the plane to be illuminated, as examples, a school chemical laboratory which may be smaller than 60m² but still need emergency lighting, as combustible materials and sources of ignition would be present, or commercial kitchens.
- It recommends that advice on the installation should be given by a competent person who specialises in emergency lighting systems.
- Continued maintenance and testing must be correctly carried out to comply with the directive.
- One way of ensuring the competence of your provider would be registration of a reputable scheme such as the BAFE (British Approvals for Fire Equipment) SP203-4 scheme.
- The equipment used must be capable of being demonstrated as of adequate quality. Compliance with the appropriate British Standard, or other approved third party scheme, gives evidence of this. The standard for luminaires is BS EN 60598-2-22. ICEL 1001 registration endorses the spacing data of these luminaires. The standard for central battery systems is BS EN 50171.

Note: When the premises are being assessed for risk, shortcomings in other areas of fire protection can be compensated for by improved levels of emergency lighting and fire alarms.

The Health & Safety (Safety Signs & Signals) Regulations 1996

These regulations bring into force the EC Safety Signs Directive (92/58/EEC) on the provision and use of safety signs at work. From 2012 the new ISO 7010 Pictogram signs will also be legal but should not be mixed with other formats on an installation.

These regulations apply to all safety signs including those which provide directional signage for escape routes.

Other Regulations

In addition to fire safety legislation, some workplaces require a licence from the Local Authority, including theatres and cinemas, sport stadiums and premises for public entertainment, music, dancing, gambling and the sale of alcohol. Other premises must be registered with the Local Authority and be inspected by the Fire Authority, including nursing homes, children's homes, residential care homes and independent schools. Both licensed and registered premises have to pass a fire inspection to confirm that they have systems complying with BS 5266-1 for the emergency lighting and BS 5839 for fire equipment. Records of a system are now essential to maintain the validity of approvals and licences.

Emergency Lighting - System Design

This section provides guidance on system design to meet BS 5266 Parts 1 and 7 and so achieve compliance with legislation.

Design Objective

BS 5266-1:2011 gives recommendations and guidance on the factors that need to be considered in the design of, and the installation and wiring of, electrical emergency escape lighting systems. This provides the lighting performance needed for safe movement of people in the event of the supply to normal lighting failing. It also gives recommendations for lighting in areas with fixed seating. From this it can be seen that you should ensure the following provisions are fulfilled.

- a) Indicate clearly and unambiguously the escape routes.
- b) Provide illumination along such routes to allow safe movement towards and through the exits provided.
- c) Ensure that fire alarm call points and fire fighting equipment, provided along escape routes can be readily located.
- d) To ensure that any area requiring special consideration as identified by the risk assessment have the necessary level of emergency illumination.
- e) To permit operations concerned with safety measures.

BS 5266-1 recommends that discussions should be held prior to commencing the design, to establish the areas to be covered, the method of operation, the testing regime and the most suitable type of system. These discussions should include the owner or occupier of the premises, the system designer, the installer and the supplier of the equipment.

At this stage the provision of plans should be made available to identify:

- a) escape routes
- b) open areas
- c) high risk task areas
- d) safety equipment, including fire safety equipment, safety signs and any other aspects identified by risk assessment
- e) details of normal lighting and its control system

Note: BS 5266 was revised in 2011. For up to date information visit our website at www.cooper-ls.com. Alternatively visit the British Standards Institute website, at www.bsi-global.com

Stage 1

Locate luminaires at mandatory "Points of Emphasis"

Initial design is conducted by situating luminaires to reveal specific hazards and highlight safety equipment and signs, in addition to providing illumination to assist safe travel along the escape route. This should be performed regardless of whether it is an emergency escape route or an open (anti-panic) area. Only when this is accomplished should the type of luminaire or its light output be considered. BS 5266 Pt 7: 1999 requires that the luminaires sited at points of emphasis must comply with BS EN 60 598-2-22.

Specific locations where a luminaire must be provided are:



At each exit door

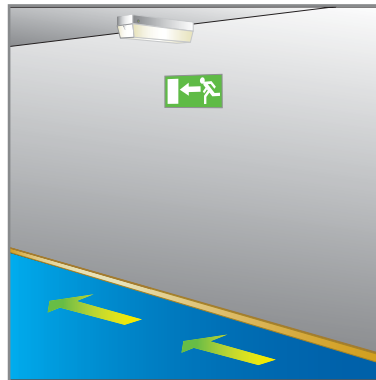

All safety exit signs

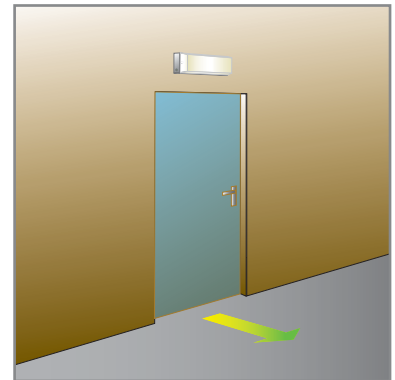

Outside the final exits and to a place of safety

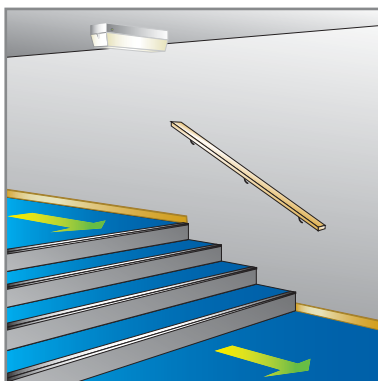

Near stairs so that each tread receives direct light

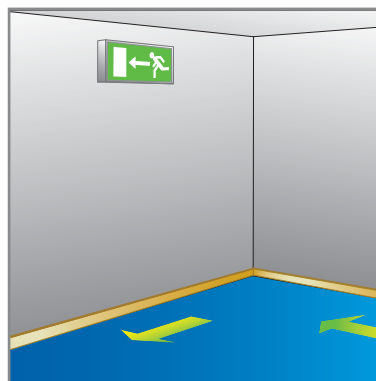

At each change of direction

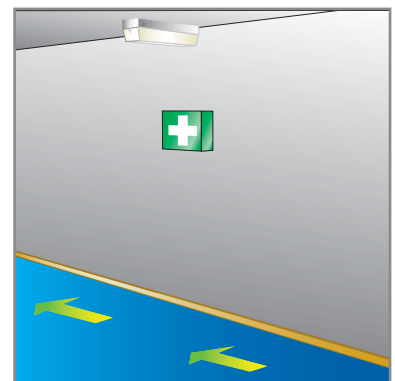

Near each first aid post

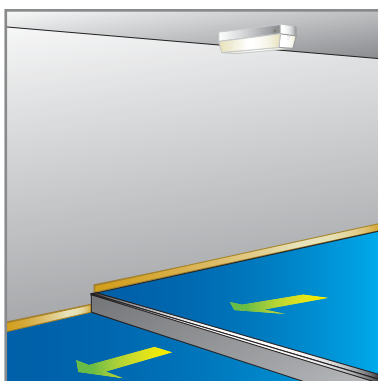

Near any other change of floor level

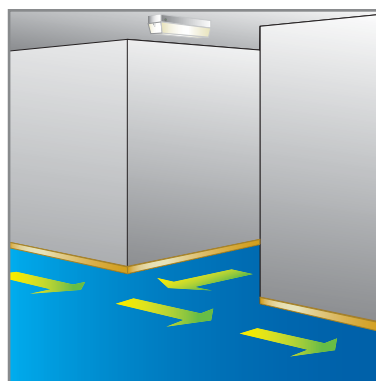

At each intersection of corridors

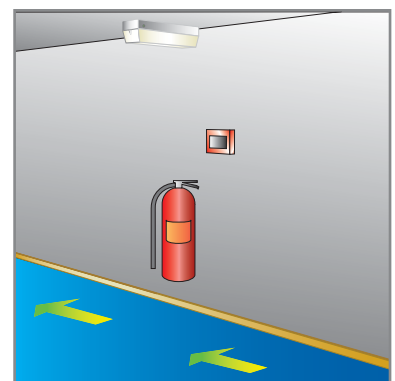

Near each piece of fire fighting equipment and call point

Note: The term near means within 2 metres measured horizontally

Emergency Lighting Design Guide

Stage 2

Ensure the exit signs are of correct format and size

Section 4.1 of BS 5266 Pt 7 states that "Signs which are provided at all exits intended to be used in an emergency and along escape routes shall be illuminated to indicate unambiguously the route of escape to a point of safety". Where direct sight of an emergency exit is not possible, an illuminated directional sign (or series of signs) shall be provided to assist progression towards the emergency exit.

- **Sign formats should not be mixed**

- **BS 2560: 197**
Old-style signs now obsolete. Should have been replaced by December 1998.



- **BS 5499 Pt 1**
Signs are still acceptable, if they are already in the building.



- **European Signs Directive Format**
This came into force on 1st April 1996, under The Signs Directive.



- **ISO 7010**
In 2011, it was decided by many of the National Standards bodies to consider adoption of a single pictogram format as detailed in ISO 7010. This format was adopted by BSI in the latest edition of BS5266: 2011 which is considered to be the 'de-facto' emergency lighting standard in the UK.



- **Maximum Viewing Distances**

For all formats of safety signs, the maximum viewing distances and luminance conditions are given in BS 5266 pt7/EN 1838 Signs can be either internally illuminated, such as exit boxes or edge lit emergency luminaires with a screened sign that have a controlled illuminance, or painted signs. These include photoluminescent signs but to be acceptable they must have an external emergency light illuminating them. Maximum viewing distances are:

Internally illuminated signs - 200 x the panel height

Externally illuminated signs - 100 x the panel height

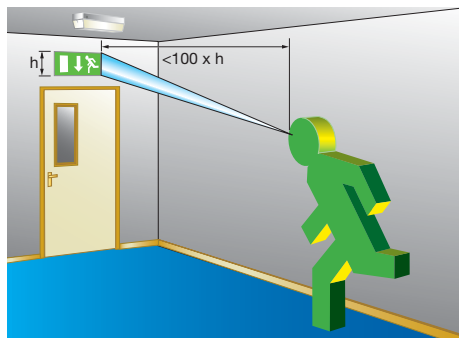
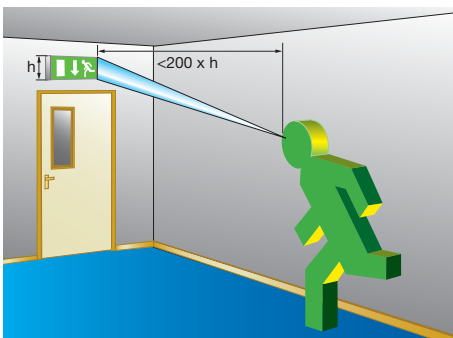

- **Illumination requirements**

The sign must conform to the colours of ISO 3864, which defines that exit and first aid signs must be white with green as the contrast colour. The ratio of luminance of the white colour to the green colour must be between 5:1 and 15:1. The minimum luminance of any 10mm patch area on the sign must be greater than 2cd/m² and the ratio of maximum to minimum luminance shall be less than 10:1 for either colour.

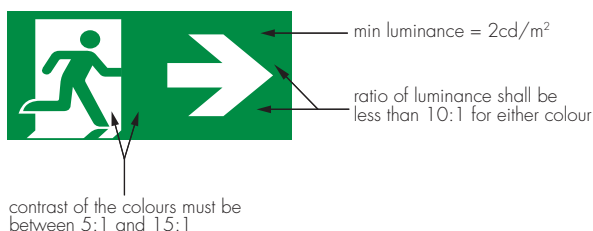

Note: Internally illuminated exit signs are pre-tested to ensure they meet these requirements, provided that they comply with EN 60598-2-22. If the sign is designed to be externally illuminated, considerable care must be taken by the system designer to see that these conditions are met. Even though an emergency luminaire must be sited within 2 metres from the sign (see stage 1) calculations should still be made to check that the sign is illuminated to 5 lux in emergency conditions.

Stage 3

Locate luminaires at the following essential areas in the buildings

These locations are not part of the escape route but because of their risk they require protection by emergency lighting. Some of these areas are specifically defined in BS 5266-1:2011. Others are likely to be hazard areas defined by the risk assessment.

- **Required for BS 5266-1: 2011**

a) Lift cars - although only in exceptional circumstances will they be part of the escape route, they do present a problem in that the public may be trapped in them in the event of a supply failure.



b) Toilets - all toilets for the disabled and facilities exceeding 8m² floor area or without borrowed lights. Note the current issue of BS 5266-1: 2011 now excludes the en suite facilities in hotels.

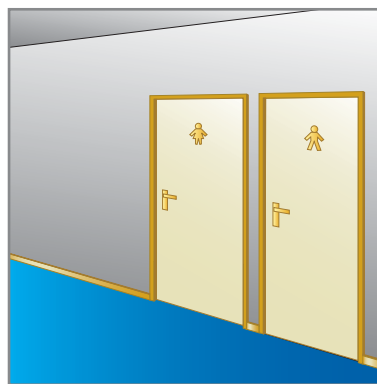

c) Escalators - to enable users to get off them safely.

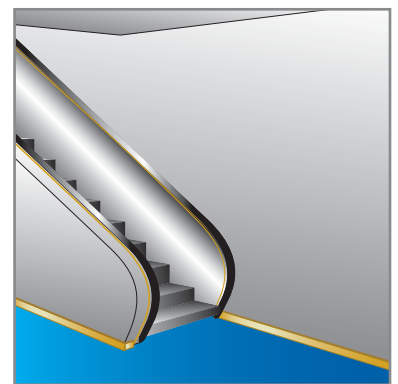

d) Motor generator, control or plant rooms - require battery supplied emergency lighting to assist any maintenance or operating personnel in the event of failure.

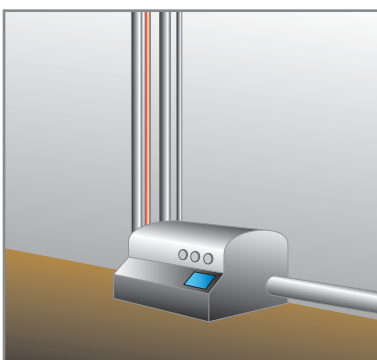

e) Covered car parks - the normal pedestrian routes should be provided with non-maintained luminaires of at least 1 hour duration.

A selection of other areas to consider are:

Kitchens - Sudden failure of lighting while staff are cooking hot food is potentially dangerous. Currently these areas would need an emergency light over the extinguisher but emergency lighting is also needed over the area for hot food preparation. Employees need to be able to locate and turn off machinery/ovens/hobs etc. to ensure that they do not turn on once the supply is re-instated and cause a possible unsafe condition.

First aid and treatment rooms - Currently the requirement is for the light level needed for the safety of the individual, however system designers need to consider the light level response and duration times of emergency lighting of first aid rooms where treatment is to be given.

Refuge areas for disabled people - In these areas fire wardens will now have to go and collect disabled persons, often transferring them into rescue sleds to enable them to be safely taken downstairs. Consideration should be given to the light level response and duration times of emergency lighting in refuges.

Fire equipment - In a fire condition, users must inspect and act on the condition of fire alarm panels and repeaters. The light must be of a sufficient level to the correct plane of visual task to enable displays to be read accurately. The staff will also have to contact the fire brigade so they must have sufficient illumination for the number to be dialled correctly in the emergency condition.

Motor generator, control or plant rooms - Require battery supplied emergency lighting to assist any maintenance or operating personnel in the event of failure.

Covered car parks - The normal pedestrian routes should be provided with non-maintained luminaires of at least 1 hour duration.

Panic bars and pads - The emergency lighting must provide adequate direct illumination on crash bars on exit doors to enable them to be easily seen and operated, consider using exit signs above with downward light panels.

Further information regarding duration and emergency illumination levels are shown in BS5266-1: 2011.

Emergency Lighting Design Guide

Stage 4

Escape Route Lighting

When the points of emphasis have been covered, it is essential to provide any additional luminaires to ensure that minimum illuminance levels are met to enable the routes to be used safely. In addition, every compartment on the escape route must have at least two luminaires, to provide some light in the event of luminaire failure.

- Lighting Level Requirements**

BS 5266 Pt 7: 1999 (EN 1838) 4.2 calls for a minimum of 1 lux anywhere on the centre line of the escape route for normal risks. A uniformity ratio of 40:1 maximum to minimum must not be exceeded. This illuminance must be provided for the full duration and life of the system. 50% of the illuminance must be available within 5 seconds and the full value within 60 seconds of supply failure.

Note: The UK had an "A deviation" which allowed a 0.2 lux minimum value for routes that will be permanently unobstructed. This has now been removed and any existing escape routes illuminate to this level must be upgraded to the current 1 lux value.

- Photometric Design**

Emergency Escape Routes

The use of authenticated spacing tables or a suitable computer program provides the information to determine whether luminaires are needed in addition to those for the points of emphasis (see data section), to provide the minimum required level of illumination on the escape routes. To ensure that the design will meet the required levels at all times the data is de-rated, as required by the standard, to cover the following factors:

- Reduction in light as the battery voltage reduces during discharge
- Ageing of lamps in maintained circuits
- The effects of dirt



Photometric Data

| Luminaire type | Mounting height (m) | Lux level directly under | Escape route 2m wide 1 lux min | | | | Open (anti-panic) area 0.5 lux min | | | |
|-----------------------|---------------------|--------------------------|-----------------------------------|------|-----|-----|---------------------------------------|------|-----|-----|
| | | | ↔ | ↔ | ↔ | ↔ | ↔ | ↔ | ↔ | |
| Self-contained | | | | | | | | | | |
| NM | 2.5 | 3.28 | 3.9 | 11.3 | 4.0 | 2.0 | 4.0 | 12.0 | 6.0 | 1.9 |
| | 4.0 | 1.28 | 2.1 | 9.6 | 5.6 | 1.2 | 3.3 | 14.8 | 7.2 | 1.9 |
| | 6.0 | 0.57 | - | - | - | - | 1.6 | 12.4 | 7.4 | 0.8 |
| M | 2.5 | 2.75 | 3.3 | 10.7 | 5.2 | 1.8 | 3.7 | 11.7 | 5.8 | 1.8 |
| | 4.0 | 1.07 | 1.5 | 8.0 | 5.0 | 0.7 | 3.5 | 14.2 | 7.0 | 1.7 |
| | 6.0 | 0.48 | - | - | - | - | - | - | - | - |

Example - luminaire spacing along escape route

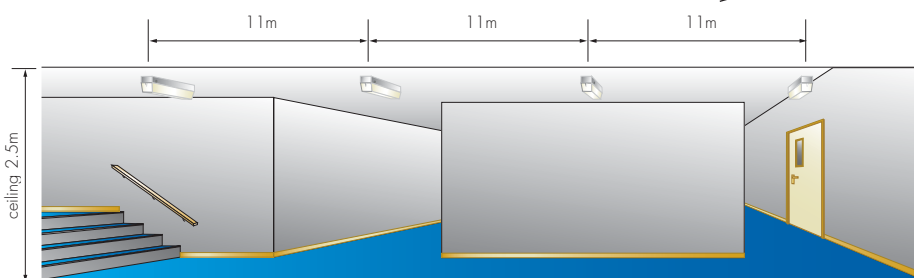
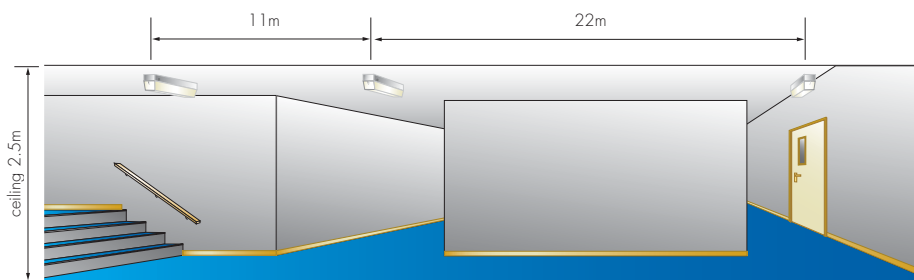

Locate luminaires at mandatory "Points of emphasis"

Add additional luminaire to achieve 1 lux minimum

Stage 5

Open (Anti-Panic) Core Areas

Areas larger than 60m², open areas with an escape route passing through them, or hazards identified by the building risk assessment all require emergency lighting. The current standard is easy to design for and to verify, promoting systems that provide good uniformity rather than ones that use a few large output luminaires.

• **Light Level Requirements**

BS 5266 Pt 7/EN 1838 - 4.3 calls for 0.5 lux minimum of the empty core area, which excludes a border of 0.5m of the perimeter of the area. Spacing tables or a suitable computer program provide simple and accurate data that can easily be used. The spacing tables for 0.5 lux are de-rated on the same basis as those for escape routes. They can also be used as a guide for initial selection of the location of luminaires when using a computer program.

If using standard mains luminaires fitted with an emergency conversion kit, you should use one of the available computer programs to calculate the layout of converted luminaires. By using the actual distribution of the luminaire ensures that the correct emergency lumen value is used with the relevant depreciation factors.

• **Spacing Data**

Specific data is available for self-contained dedicated emergency luminaires. This can be found on each of the individual product entries in this catalogue.

Luminaire spacing in open (anti-panic) core areas

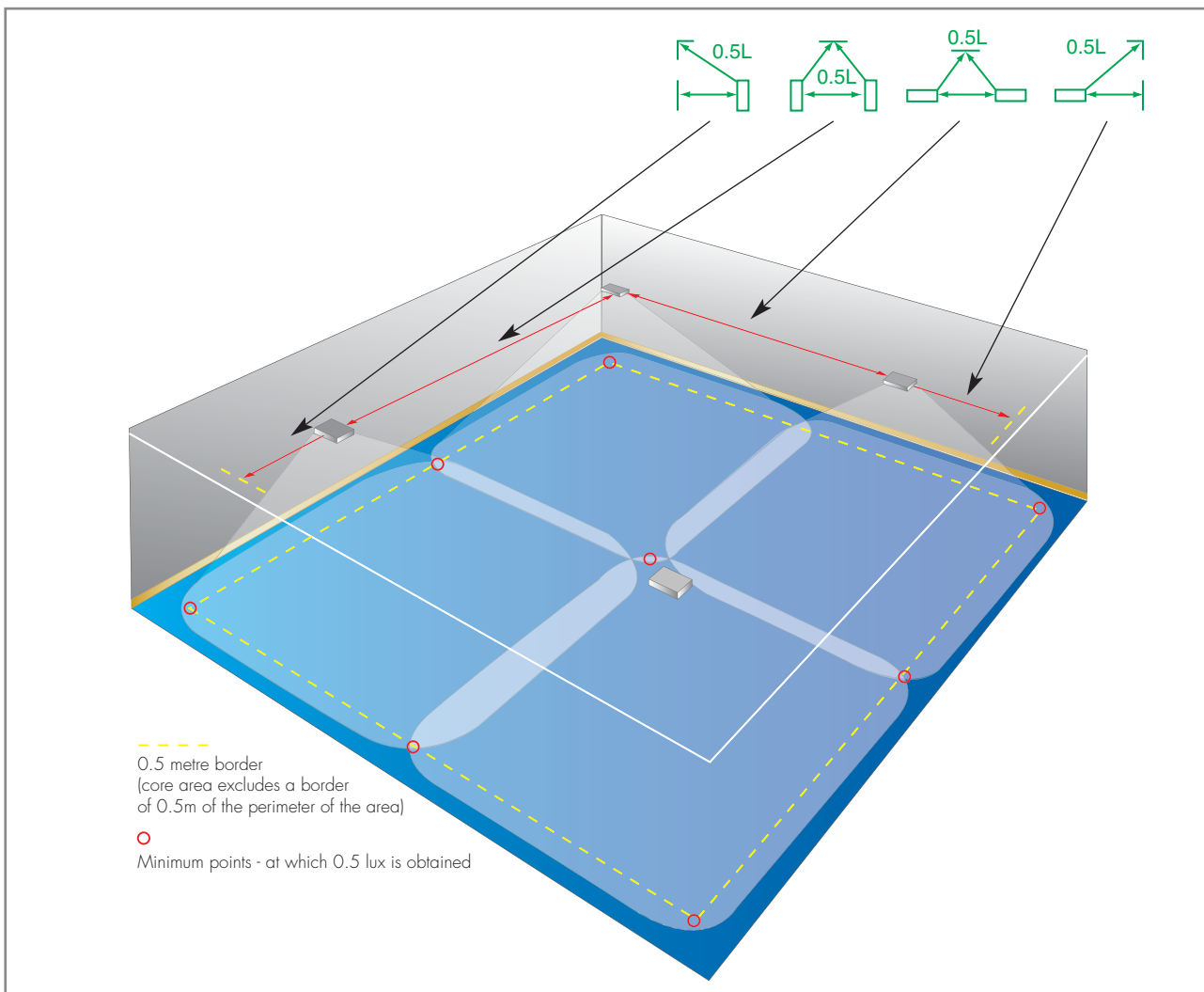

Emergency Lighting Design Guide

Stage 6

High risk task area lighting

The risk assessment carried out will have identified a number of locations needing special consideration. These may be areas in which plant and production lines are deemed to have a high risk or control rooms managing dangerous processes. In addition to these identified areas a selection of other typical areas are detailed in BS5266-1:2011.

BBS5266-7:1999/EN1838:1999 defines that in areas of high risk the maintained illuminance on the reference plane shall be not less than 10% of the required maintained illuminance for that task, however it shall not be less than 15 lux.

Design Procedures

In order to reach this enhanced level of emergency illumination it is important to consider all options, which may include converted luminaires, either operated from integral batteries or the use of luminaires supplied from a central emergency unit. These versions in most instances would have higher Ballast Lumen factors (BLF). It is also important to consider the emergency response time which may require that the emergency luminaires are operated in maintained mode, or possibly require the use of tungsten projector units. If these are used it is important to maintain a reasonable level of uniformity.

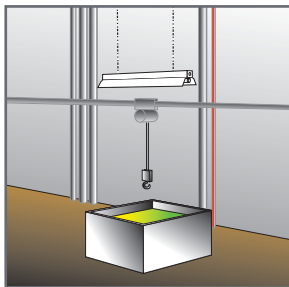

Stage 7

Control

Non-maintained luminaires must be activated by failure of supply to the normal lighting. They must therefore be connected to an un-switched live taken from the local normal lighting final circuit.

It is important at this stage to ensure that the luminaires used in the design process are not changed without a full assessment of the lumen output and distribution of any alternative proposal. Failure to validate the performance could lead to a non-compliant installation.

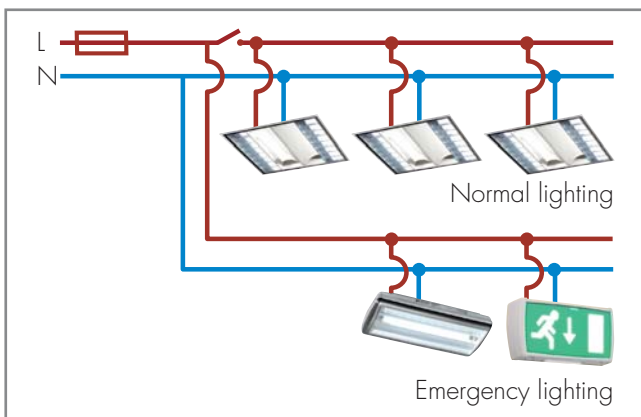

Stage 7 (cont'd)

Testing and Log Book

The Fire Safety Order requires that appropriate testing is performed to maintain compliance of the system. The system should include adequate facilities for testing and recording the system condition. These need to be appropriate for the specific site and should be considered as part of the system design. Discussions with the user or system designer should identify:

- The calibre and reliability of staff available to do the testing
- The level of difficulty in performing the test
- If discharge tests need to be done outside normal working hours, or phased so only alternate luminaires are tested in buildings that are permanently occupied

The testing requirements in the code of practice are:

• Function Test

All emergency luminaires should be tested by breaking the supply to them and checking that they operate satisfactorily. The supply must then be restored and the charging indicators must be seen to be operating correctly. This test must be performed at least once per month and the results logged.

• Discharge Test

The luminaires must be tested for their full rated duration period and checked for satisfactory operation. The supply must then be restored and the charging indicators rechecked. This test must be performed at least annually and the results logged.

If manual testing is utilised, the following points should be considered:

- Is a single switch to be used? Unless the whole building is to be switched off, a separate switch should be used for each final circuit. As the feed to non-maintained circuits must be taken from the switch, this will probably mean that the building will have to be walked around twice, once to check the luminaires and once to check that they are recharging.
- With manual testing it is difficult to correctly validate that the emergency luminaires illuminated within the specified time and at the correct level. Validation is also required that all emergency luminaires meet the minimum duration. Again, this would be difficult to validate for all locations.

Stage 7 (cont'd)

- Are luminaires to be individually switched? In practice, only a single walk around the building will be needed. However, the test switches could spoil the décor of the building and they must be of a type that is tamper proof.
- After the tests, the performance of the luminaires must be logged.

Commissioning Certificate

BS 5266 Pt 1: 2011 and the European Standard both require written declarations of compliance to be available on site for inspection. These consist of:

1. Installation quality
IEE regulations must have been conformed with and non-maintained fittings fed from the final circuit of the normal lighting in each, as required in BS 5266 Pt 1: 2011.
2. Photometric performance
Evidence of compliance with light levels has to be supplied by the system designer. Photometric tests for Cooper Lighting and Safety luminaires are normally performed at BSI and spacing data is registered by the ICEL scheme. Therefore copies of the spacing data in this catalogue provides the verification required.
3. Declaration of a satisfactory test of operation. A log of all system tests and results must be maintained. System log books, with commissioning forms, testing forms and instructions are available from Cooper Lighting and Safety.

Maintenance

Finally, to ensure that the system remains at full operational status, essential servicing should be defined. This normally would be performed as part of the testing routine, but in the case of consumable items such as replacement lamps, spares should be provided for immediate use.

Cooper Lighting and Safety can provide a full maintenance service for your emergency lighting system by fully qualified BAFE registered engineers. For more information, call our service team on 01302 303349.

Automatic Test Systems

Legislation demands that emergency lighting systems are regularly tested and maintained in full working order. To avoid the cost and disruption of manual testing, automatic test systems should be considered. Cooper Lighting and Safety offer two alternative testing systems, each optimised for different building types:

- **EasiCheck**

Particularly suited to medium to large sized installations, EasiCheck is a versatile addressable emergency lighting test system. It uses a central control panel to perform automatic test schedules, initiate manual tests and download event logs and test reports. It is available for use with both self-contained luminaires and central power systems. EasiCheck continuously monitors all components of an emergency lighting system, reporting faults as soon as they occur. Up to 63 panels can be networked together, ensuring EasiCheck can be utilised in the largest of projects of up to 12,600 emergency luminaires. It also has advanced software options for PC monitoring and control.



EasiCheck Panel

- **Intellem**

Designed for use with self-contained emergency luminaires, Intellem is a stand alone self-test system for small to medium sized installations. The testing module self calibrates and carries out testing at predetermined intervals. Faults are precisely reported by an audible alarm and the flashing sequence of the LED indicator. For applications where an audible alarm would be inappropriate, this feature can be disabled during installation. Intellem has a function which enables tests of adjacent luminaires to be staggered to avoid complete loss of emergency cover during the recharge period after a full discharge test.

Emergency Lighting Design Guide

Example of System Design

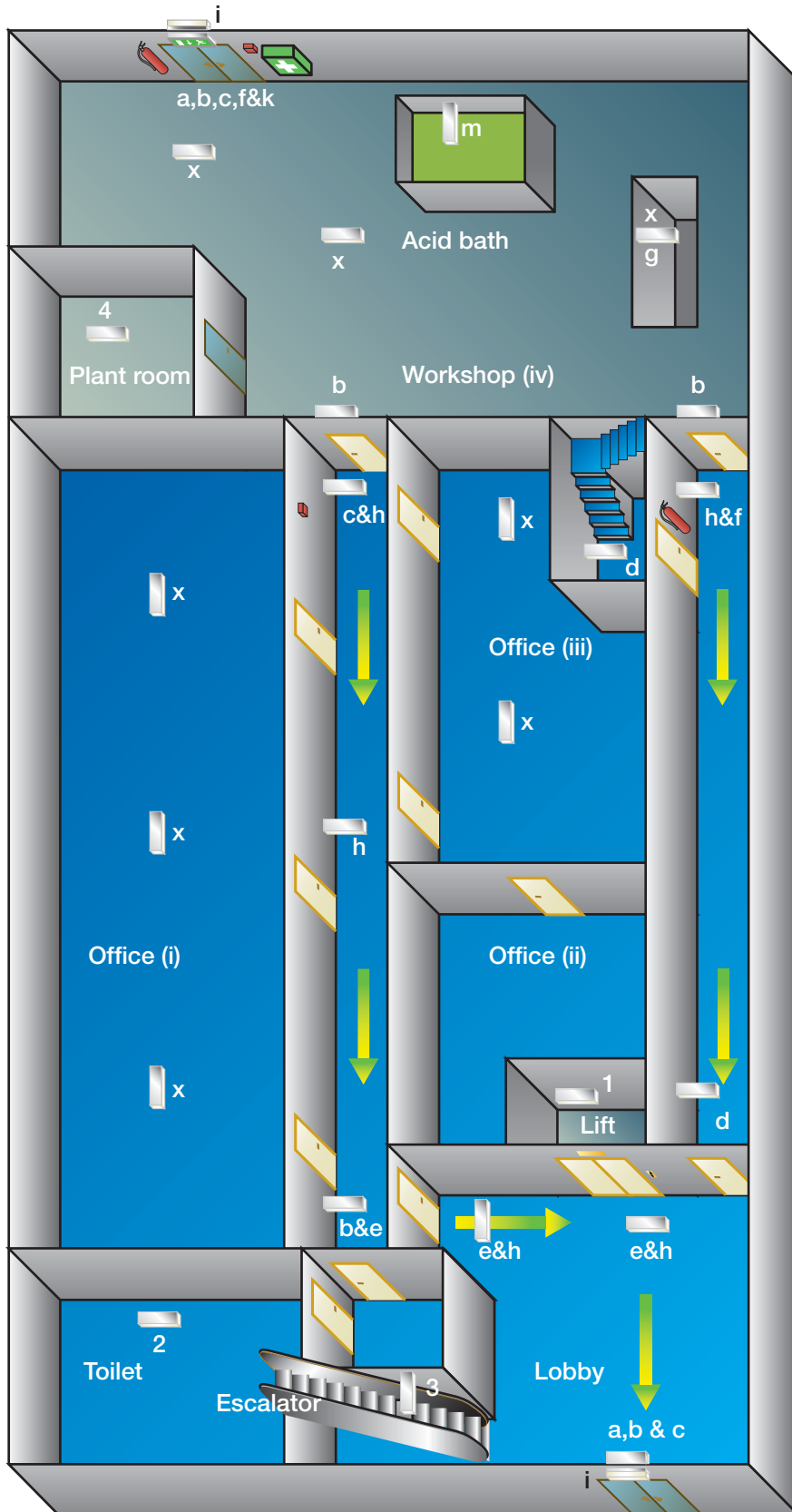

Example of System Design

Stage 1

Locate luminaires at points of emphasis on escape route

- a At each exit door
- b To illuminate exit and safety signs
- c Near call points (some covered by a.)
- d Near each staircase
- e Change of direction (some covered by b.)
- f Near fire fighting equipment (some covered by a.)
- g Change of floor level
- h Near intersection of escape routes
- i Outside final exits
- k Near first aid points

Stage 2

Exit sign location is covered by Stage 1, but it is important to check that maximum viewing distances are not exceeded and that if the normal lighting is dimmed, e.g. in cinemas, the exit signs must be permanently illuminated while the building is occupied (maintained lighting).

Stage 3

Other areas, which require emergency lighting but are not on the escape route area.

- 1 Lift car
- 2 Toilet (above 8m² floor area)
- 3 Escalators
- 4 Plant room

Stage 4

Check minimum illuminance levels on the escape routes. After selecting a suitable luminaire, consulting the spacing table shows the number of fittings needed to provide a minimum of 1 lux on the centre line of the escape routes.

Stage 5

Anti-panic open areas (x) apply to any areas over 60m² floor area, or that have an escape route passing through them.

- (i) Office over 60m²
 - 3 x Micropoint 2
- (ii) Office under 60m²
 - no requirement
- (iii) Under 60m², but part of escape route from office
 - 2 x Micropoint 2 fittings, either as compartment of escape route or an open anti-panic area
- (iv) Workshop 4m high
 - 3 x i-P65 + maintained Alfalux High-bay LED unit for high risk (m)

Stage 6

High risk lighting requirement for an acid bath (m) is included in the design for stage 5. However an alternative option would be the use of a suitable high powered tungsten projector such as Beamlite.

Wiring Installation

The wiring of emergency luminaires should generally be in accordance with normal wiring practice (I.E.E. Wiring Regulations), statutory requirements applicable to the type of building, local by-laws and regulations. The supply for self contained luminaires should be taken from the unswitched local light source.

Cabling used when installing self-contained emergency luminaires should be of a similar type to that used for the normal mains light. In the event of a fire, if the cabling used for the emergency luminaires has greater protection, there may be a chance of the normal lighting failing and the emergency lighting remaining in the normal mode (i.e. inoperative). Hence it is recommended that self-contained emergency luminaires are wired in PVC insulated cable.

The supply to self-contained luminaires should be such as to prevent unauthorised disconnection, but should incorporate suitable means for simulating a mains failure for test purposes. The source of supply should be from the same local fuse as the normal lighting, so that in the event of a fuse failure causing the normal lighting to be extinguished, the emergency lighting is brought into operation in the same locality.

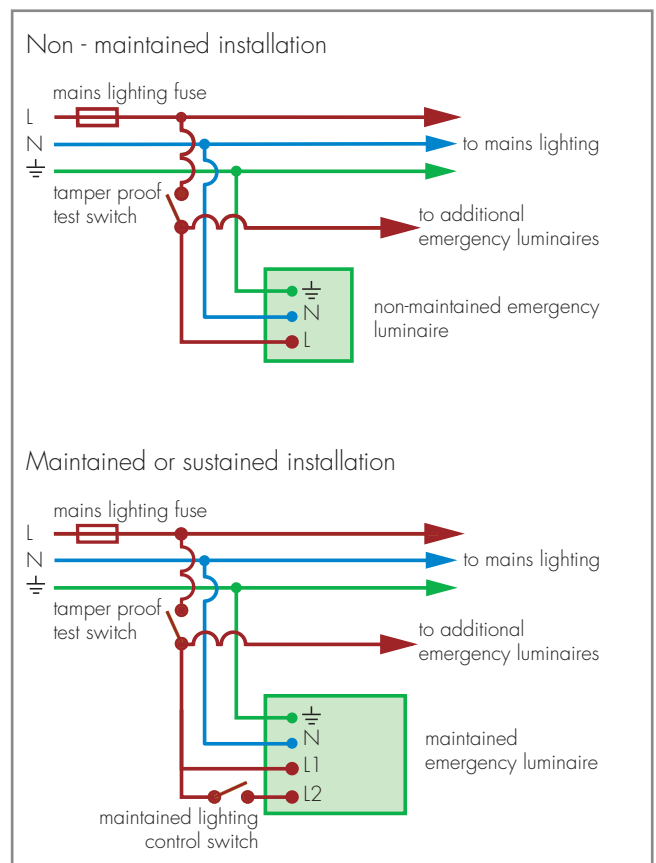

Wiring details